



# 1153 Series

## Heavy Duty 2" Wide General Purposes Caster (European Style)

○ Pressed steel caster horn/ housing designed for European market. Swivel easily with high performance total lock brake, suitable for medium and heavy duty logistic equipment.

Load  
125-350 kg



### » Features



Rear Total Lock



Front Total Lock



Swivel with Central, Total Lock



Directional Lock

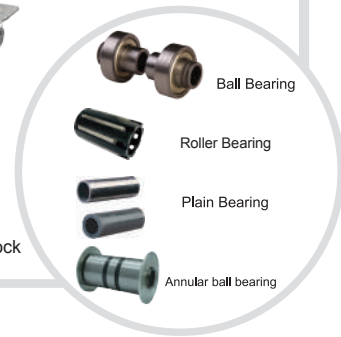

### » Wheel Options



QPU on AL Core



EQPU



VQPU



Rubber on AL Core



Nylon Wheel



Resilient Resolute Wheel (Blue Tread)



Resilient Resolute Wheel (Gray Tread)



Black Rubber Wheel (Steel Core)



Gray Rubber Wheel (Steel Core)



Black Rubber Wheel (Plastic Core)



Gray Rubber Wheel (Plastic Core)

### » TOP PLATE SIZE AND BOLT HOLE SPACING

Suffix	Top Plate Size	Bolt Hole Spacing	Attaching Bolt Size
1	137 x 105mm(5-3/8" x 4-1/8")	105 x 80/75mm(4-1/8" x 3-1/8")	10mm (3/8")
2	137 x 105mm(5-3/8" x 4-1/8")	92.5 x 84.5mm(3-5/8" x 3-5/16")	M10 (3/8")
3	137 x 105mm(5-3/8" x 4-1/8")	118 x 75mm(4-11/16" x 3")	M10 (3/8")











▶ SINGLE BOLT HOLE

Suffix	Centre Hole
1	13mm

Diameter×Width	Load	Material	Item NO.			Bearing	Overall Height	Offset (mm)	Swivel radius (mm)
			Fixed	Swivel	Brake				
150 x 40mm (6" x 1-9/16")	280kgs (615 lbs)	Rubber on Aluminum Core	1153-06-22-1	1153-06-22-2	1153-06-22-4	Ball Bearing	190mm (7-1/2")	55mm	Swivel 131mm Swivel W/Rear total lock 131mm Swivel W/Front total lock 165mm
	350kgs (770 lbs)	Nylon Wheel	1153-06-45-1	1153-06-45-2	1153-06-45-4	Ball Bearing			
	125kgs (275 lbs)	Black Rubber Wheel(Steel Core)	1153-06-103-1	1153-06-103-2	1153-06-103-4	Roller Bearing			
	125kgs (275 lbs)	Black Rubber Wheel(Plastic Core)	1153-06-104-1	1153-06-104-2	1153-06-104-4	Roller Bearing Plain Bearing			
	125kgs (275 lbs)	Gray Rubber Wheel(Steel Core)	1153-06-106-1	1153-06-106-2	1153-06-106-4	Roller Bearing			
	125kgs (275 lbs)	Gray Rubber Wheel(Plastic Core)	1153-06-107-1	1153-06-107-2	1153-06-107-4	Roller Bearing Plain Bearing			
150 x 42mm (6" x 1-5/8")	350kgs (770 lbs)	QPU on AL Core (Round)	1153-06-87-1	1153-06-87-2	1153-06-87-4	Ball Bearing	190mm (7-1/2")	55mm	Swivel 131mm Swivel W/Rear total lock 131mm Swivel W/Front total lock 165mm
	350kgs (770 lbs)	EQPU (Round)	1153-06-81-1	1153-06-81-2	1153-06-81-4				
	350kgs (770 lbs)	EQPU (Flat)	1153-06-81-1	1153-06-81-2	1153-06-81-4				
	350kgs (770 lbs)	VQPU (Round)	1153-06-83-1	1153-06-83-2	1153-06-83-4				
150 x 50mm (6" x 2")	350kgs (770 lbs)	QPU on AL Core (Flat)	1153-06-87-1	1153-06-87-2	1153-06-87-4	Ball Bearing	190mm (7-1/2")	55mm	Swivel 131mm Swivel W/Rear total lock 131mm Swivel W/Front total lock 165mm
160 x 40mm (6-5/16" x 1-9/16")	350kgs (770 lbs)	Nylon Wheel	1153-65-45-1	1153-65-45-2	1153-65-45-4	Ball Bearing	200mm (7-7/8")	55mm	Swivel 136mm Swivel W/Rear total lock 136mm Swivel W/Front total lock 165mm
						Plain Bearing			
						Roller Bearing			
						Annular ball bearing			
	135kgs (295 lbs)	Black Rubber Wheel(Steel Core)	1153-65-103-1	1153-65-103-2	1153-65-103-4	Roller Bearing			
135kgs (295 lbs)	Black Rubber Wheel(Plastic Core)	1153-65-104-1	1153-65-104-2	1153-65-104-4	Roller Bearing Plain Bearing				
135kgs (295 lbs)	Gray Rubber Wheel(Steel Core)	1153-65-106-1	1153-65-106-2	1153-65-106-4	Roller Bearing				
135kgs (295 lbs)	Gray Rubber Wheel(Plastic Core)	1153-65-107-1	1153-65-107-2	1153-65-107-4	Roller Bearing Plain Bearing				
160 x 42mm (6-5/16" x 1-5/8")	350kgs (770 lbs)	QPU on AL Core (Round)	1153-65-87-1	1153-65-87-2	1153-65-87-4	Ball Bearing	200mm (7-7/8")	55mm	Swivel 136mm Swivel W/Rear total lock 136mm Swivel W/Front total lock 165mm
	300kgs (660 lbs)	Rubber on Aluminum Core	1153-65-22-1	1153-65-22-2	1153-65-22-4	Ball Bearing			
160 x 48mm (6-5/16" x 1-7/8")	300kgs (660 lbs)	Resilient Resolute Wheel (Gray tread)	1153-65-105-1	1153-65-105-2	1153-65-105-4	Ball Bearing Roller Bearing	200mm (7-7/8")	55mm	Swivel 136mm Swivel W/Rear total lock 136mm Swivel W/Front total lock 165mm
		Resilient Resolute Wheel (Blue tread)	1153-65-50-1	1153-65-50-2	1153-65-50-4	Annular ball bearing Ball Bearing Roller Bearing Annular ball bearing			



 Diameter×Width	 Load	 Material	 Item NO.			 Bearing	 Overall Height	 Offset (mm)	 Swivel radius (mm)
			Fixed	Swivel	Brake				
160 x 50mm (6-5/16" x 2")	350kgs (770 lbs)	QPU on AL Core (Flat)	1153-65-87-1	1153-65-87-2	1153-65-87-4	Ball Bearing	200mm (7-7/8")	55mm	Swivel 136mm Swivel W/Rear total lock 136mm Swivel W/Front total lock 165mm
180 x 44mm (7" x 1-3/4")	350kgs (770 lbs)	QPU on AL Core (Round)	1153-07-87-1	1153-07-87-2	1153-07-87-4	Ball Bearing	220mm (8-11/16")	55mm	Swivel 145mm Swivel W/Rear total lock 145mm Swivel W/Front total lock 165mm
180 x 50mm (7" x 2")	175kgs (385 lbs)	Black Rubber Wheel(Steel Core)	1153-07-103-1	1153-07-103-2	1153-07-103-4	Roller Bearing	220mm (8-11/16")	55mm	Swivel 145mm Swivel W/Rear total lock 145mm Swivel W/Front total lock 165mm
	175kgs (385 lbs)	Black Rubber Wheel(Plastic Core)	1153-07-104-1	1153-07-104-2	1153-07-104-4	Roller Bearing Plain Bearing			
	175kgs (385 lbs)	Gray Rubber Wheel(Steel Core)	1153-07-106-1	1153-07-106-2	1153-07-106-4	Roller Bearing			
	175kgs (385 lbs)	Gray Rubber Wheel(Plastic Core)	1153-07-107-1	1153-07-107-2	1153-07-107-4	Roller Bearing Plain Bearing			
200 x 44mm (8" x 1-3/4")	350kgs (770 lbs)	Rubber on Aluminum Core	1153-08-22-1	1153-08-22-2	1153-08-22-4	Ball Bearing	240mm (9-1/2")	55mm	Swivel 155mm Swivel W/Rear total lock 155mm Swivel W/Front total lock 165mm
200 x 48mm (8" x 1-7/8")	325kgs (715 lbs)	Resilient Resolute Wheel (Gray tread)	1153-08-105-1	1153-08-105-2	1153-08-105-4	Ball Bearing Roller Bearing Annular ball bearing	240mm (9-1/2")	55mm	Swivel 155mm Swivel W/Rear total lock 155mm Swivel W/Front total lock 165mm
	325kgs (715 lbs)	Resilient Resolute Wheel (Blue tread)	1153-08-50-1	1153-08-50-2	1153-08-50-4	Ball Bearing Roller Bearing Annular ball bearing			
200 x 50mm (8" x 2")	350kgs (770 lbs)	QPU on AL Core (Flat)	1153-08-87-1	1153-08-87-2	1153-08-87-4	Ball Bearing	240mm (9-1/2")	55mm	Swivel 155mm Swivel W/Rear total lock 155mm Swivel W/Front total lock 165mm
	350kgs (770 lbs)	QPU on AL Core (Round)	1153-08-87-1	1153-08-87-2	1153-08-87-4				
	350kgs (770 lbs)	EQPU (Round)	1153-08-81-1	1153-08-81-2	1153-08-81-4				
	350kgs (770 lbs)	EQPU (Flat)	1153-08-81-1	1153-08-81-2	1153-08-81-4				
	350kgs (770 lbs)	VQPU (Round)	1153-08-83-1	1153-08-83-2	1153-08-83-4				
	350kgs (770 lbs)	Nylon Wheel	1153-08-45-1	1153-08-45-2	1153-08-45-4	Ball Bearing Plain Bearing Roller Bearing Annular ball bearing			
	205kgs (450 lbs)	Black Rubber Wheel(Steel Core)	1153-08-103-1	1153-08-103-2	1153-08-103-4	Roller Bearing			
	205kgs (450 lbs)	Black Rubber Wheel(Plastic Core)	1153-08-104-1	1153-08-104-2	1153-08-104-4	Roller Bearing Plain Bearing			
	205kgs (450 lbs)	Gray Rubber Wheel(Steel Core)	1153-08-106-1	1153-08-106-2	1153-08-106-4	Roller Bearing			
	205kgs (450 lbs)	Gray Rubber Wheel(Plastic Core)	1153-08-107-1	1153-08-107-2	1153-08-107-4	Roller Bearing Plain Bearing			