











VXPU Series

EXTRA HEAVY DUTY WHEEL

with Xtremethane tread,
with steel/cast iron core

	Tread & tyre hardness		90° shore A
	Temperature resistance		-30°C to +70°C
	Rolling resistance		very good
	Operating noise		good
	Floor surface preservation		good



Tread

Xtremethane wheels are built to carry high load at high speed. Regular tread hardness is $90 \pm 3^\circ$ shore A. It has great mechanical properties, including high dynamic load capacity, superd wear resistant and very low compression set. Xtremethane also have great capability to tackle the internet heat build-up issue, which makes them suitable for applications like forklift trucks, electric stackers, heavy duty machines, AGV and automotive industry.

Wheel centre/rim

Made of rugged casting iron/steel

Other features

Good resistant to chemical, solvent and many other aggressive substances.

Great abrasion resistance.

Working temperature: -30°C to $+70^\circ\text{C}$.

Maintenance-free under normal conditions.

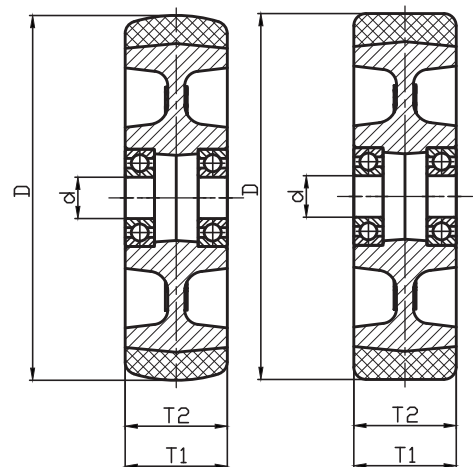

Item No	Wheel Diameter (D) [mm]	Wheel Width (T2) [mm]	Load Capacity [kg] (lbs)	Axle Bore \varnothing (d) [mm]	Hub Length (T1) [mm]	Tread Profile	Bearing Type
12036906186171	150	42	700 kgs (1543lbs)	17	42	Round	Ball bearing
12036906186271	150	42	700 kgs (1543lbs)	20	42		
12036906306171	150	75	1100 kgs (2425lbs)	20	75		
12036906306271	150	75	1100 kgs (2425lbs)	25	75		
12036907206171	180	50	850 kgs (1874lbs)	20	50		
12036907206271	180	50	850 kgs (1874lbs)	25	50		
12036908206171	200	50	1000 kgs (2205lbs)	20	50		
12036908206271	200	50	1000 kgs (2205lbs)	25	50		
12035108206371	200	50	1000 kgs (2205lbs)	30	50		
12035108206471	200	50	1000 kgs (2205lbs)	35	50		
12035108206571	200	50	1000 kgs (2205lbs)	40	50		
12036910256171	250	62	1500 kgs (3307lbs)	20	61		
12036910256271	250	62	1500 kgs (3307lbs)	25	61		
12036910256371	250	62	1500 kgs (3307lbs)	30	61		
12036910256471	250	62	1500 kgs (3307lbs)	35	61		
12036912356171	300	90	1800 kgs (3968lbs)	30	90		
12036912356271	300	90	1800 kgs (3968lbs)	35	90		
12036914356201	350	90	2500 kgs (5512lbs)	35	90		
12036914356101	350	90	2500 kgs (5512lbs)	40	90		
12036914356301	350	90	2500 kgs (5512lbs)	45	90		
12036914356401	350	90	2500 kgs (5512lbs)	50	90		
12036910306171	250	80	2000 kgs (4409lbs)	25	90	Flat	
12036910306271	250	80	2000 kgs (4409lbs)	30	90		
12036910306371	250	80	2000 kgs (4409lbs)	35	90		
12036912356371	300	90	2400 kgs (5291lbs)	30	90		
12036912356471	300	90	2400 kgs (5291lbs)	35	90		
12036916406171	400	100	3800 kgs (8378lbs)	35	100		
12036916406271	400	100	3800 kgs (8378lbs)	40	100		
12036916406371	400	100	3800 kgs (8378lbs)	45	100		
12036916406471	400	100	3800 kgs (8378lbs)	50	100		